

Entertainment Unlimited
www.next-base.com

NEXT BASE Gallery 13-S

7" Digital Photo Frame
Ready to Show



CONTENTS

CONTENTS.....	1
IMPORTANT SAFETY INSTRUCTIONS.....	2
GENERAL INTRODUCTION.....	3
PACKING CONTENTS.....	4
PARTS AND CONTENTS.....	5
Button definitions.....	5
Right side.....	5
Bottom side.....	5
Back side.....	6
Connect to the 7" x 5" frame.....	6
Frame mount.....	7
How to use the stand support.....	7
CONNECTIONS.....	8
Connect the adapter to the socket.....	8
Inserting a memory card to Gallery 13-S.....	8
Inserting a USB stick to Gallery 13-S.....	9
BASIC OPERATIONS.....	10
Turn on or turn off the machine.....	10
SETUP.....	11
Watch movie.....	11
View photo.....	12
Displaying effect.....	13
Change settings.....	15
Settings-Photo Setting.....	15
Settings-Preview.....	16
Settings-Display Setup.....	18
Settings-Custom Setup.....	19
OTHER.....	20
Dimension and parameter.....	20
Trouble shooting.....	21
Smashed screen identification.....	21

IMPORTANT SAFETY INSTRUCTIONS

1. Read these instructions.
2. Keep these instructions.
3. Heed all warnings.
4. Follow all instructions.
5. Do not use this apparatus near water.
6. Clean only with dry cloth.
7. Do not block any ventilation openings. Install in accordance with the manufacturer's instructions.
8. Do not install near any heat sources such as radiators, heat registers, stoves, or other apparatus (Including amplifiers) that produce heat.
9. Do not defeat the safety purpose of the polarized or grounding-type plug. A polarized plug has two blades with one wider than the other. A grounding type plug has two blades and a third grounding prong. The wide blade or the third prong are provided for your safety. If the provided plug does not fit into your outlet, consult an electrician for replacement of the obsolete outlet.
10. Protect the power cord from being walked on or pinched particularly at plugs, convenience receptacles, and the point where they exit from the apparatus.
11. Only use attachments/accessories specified by the manufacturer.
12. Unplug this apparatus during lightning storms or when unused for long periods of time.
13. Refer all servicing to qualified service personnel. Servicing is required when the apparatus has been damaged in any way, such as power-supply cord or plug is damaged, liquid has been spilled or objects have fallen into the apparatus, the apparatus has been exposed to rain or moisture, does not operate normally, or has been dropped.
14. To reduce the risk of fire or electric shock, do not expose this appliance to rain or moisture.
15. Apparatus shall not be exposed to dripping or splashing and no objects filled with liquids, shall be placed on the apparatus.
16.  WEEE statement: Please do not throw electronic devices into household waste and separate them for correct recycling.

GENERAL INTRODUCTION

Thank you for purchasing this digital photo frame. Please read this manual carefully before operating and reserve it for future reference.

Nextbase Gallery 13-S digital photo frame can be used with friendly user interface. Its flag design, allows you to use it like a pocket book. It can be placed either vertically or horizontally to fit the photos on display. You can place it somewhere in a room for a continuous display by simply connecting it to the mains power supply.

PACKING CONTENTS

Gallery 13-S

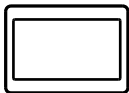

AC-DC Adapter



Frame Mount

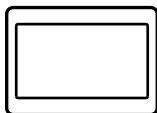

User Manual



Quick Start



PARTS AND CONTENTS

BUTTON DEFINITIONS

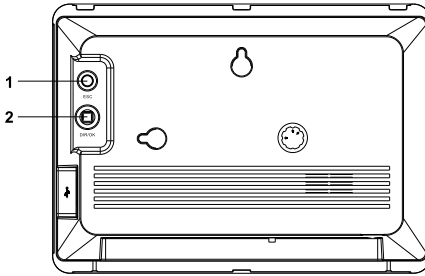

1. ESC (Escape)

2. DIR /OK

RIGHT SIDE

1. USB port
Connect USB memory stick here.

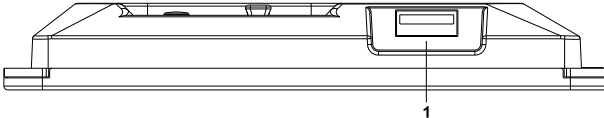

BOTTOM SIDE

1. DC IN 5V
Connect the included AC /DC adapter here.
2. ON/OFF
3. Card Jack
Support SD /MMC /MS /xD cards.



BACK SIDE

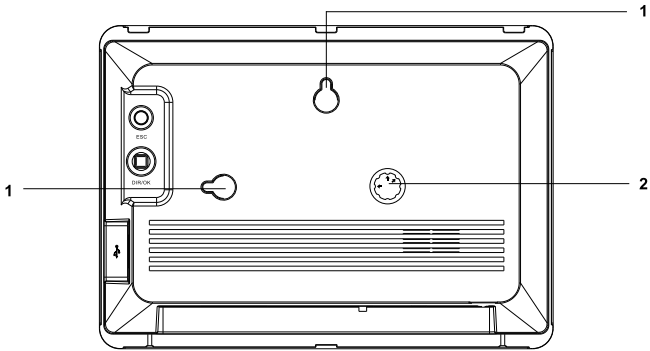

1. Wall hanging mount (Horizontal or vertical option)
2. Round slot for stand . Stand can be blocked in this round slot. (see page7).

CONNECT TO THE 7" X 5" FRAME

Nextbase Gallery 13-S can be fitted to match all standard 7" X 5" wooden frames as shown below:

1. Match the standard 7" X 5" frame with Gallery 13-S.
2. Move the locking latches upon the frame to secure the Gallery 13-S.

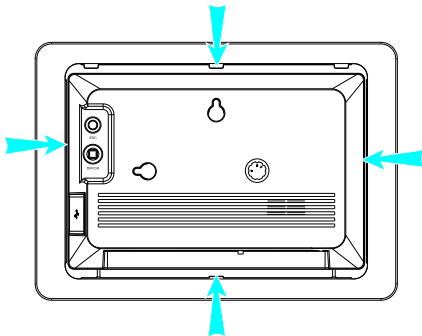

FRAME MOUNT

Your Nextbase Gallery 13-S can be mounted with all standard 8" X 6" wooden frames by using the frame mount contained in the accessories:

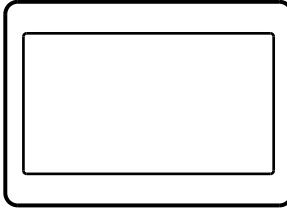

HOW TO USE THE STAND SUPPORT

Nextbase Gallery 13-S can be placed on a table top using the support. The Gallery 13-S can be positioned horizontally or vertically as desired.

1. The picture shows the effect after installing the stand.
2. Round slot for stand.
3. Install the stand from different angles to make the machine standing vertically or horizontally.
4. Install the stand according to the four directions shown in the pictures, it can be placed stable after installing the stand.
5. Lean the Gallery 13-S back to the desired position.

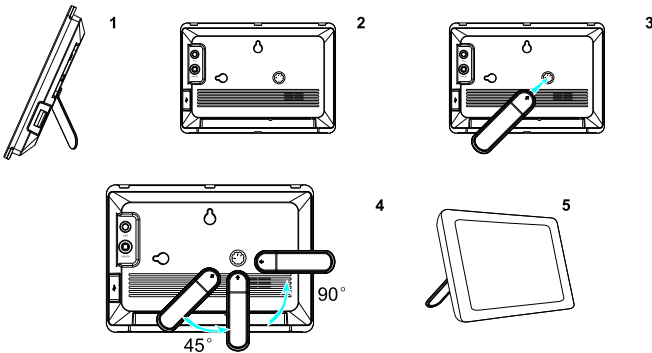

CONNECTIONS

1. CONNECT THE ADAPTER TO THE SOCKET

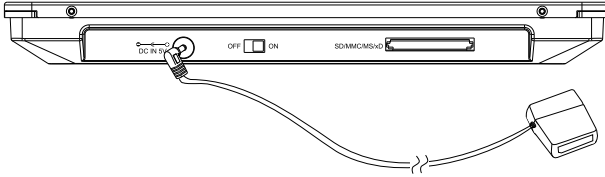

2. INSERTING A MEMORY CARD TO GALLERY 13-S

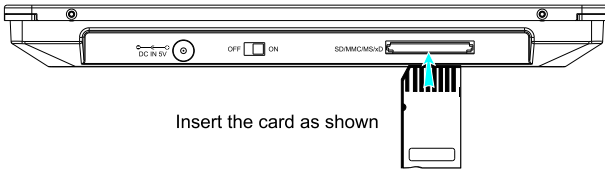

Note:

1. Because of various size of memory card provided by different suppliers, please adjust the angle slightly if the memory card can't be read.
2. The mini SD adapter or dual voltage SD cards may not be recognized by the Gallery 13-S.
3. Please do not use the MS-PRO adapter with a raised paint surface, or damage to the Gallery 13-S may be caused.

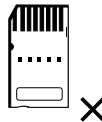
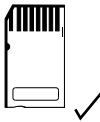

3. INSERTING A USB STICK TO GALLERY 13-S

Insert the USB stick as shown.

Note:

1. Support USB2.0.
2. Support JPEG BMP MPEG1 MPEG2 MPEG4.
3. Does not support audio only files.
4. Connect the memory stick directly to the Gallery 13-S. Do not use an external cable or this may cause problems.

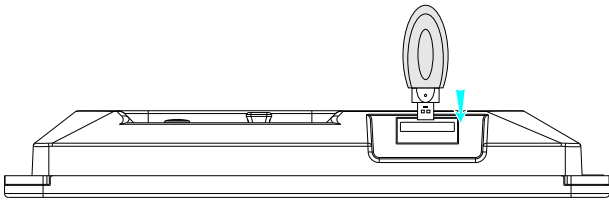

BASIC OPERATIONS

TURN ON OR TURN OFF THE MACHINE

1. Connect the AC-DC adapter to a socket.
2. Connect the DC output plug of the adapter to the DC input jack of the main unit.
3. Turn the switch to **On** to turn on the power, and turn the switch to **Off** to turn off the power.

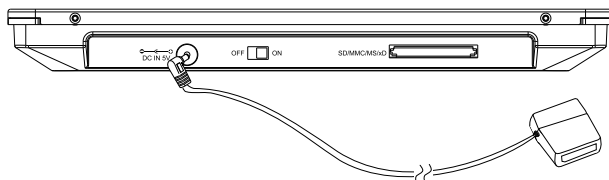

There are three options after turning on the power: **Watch Movie**, **View Photo**, **Change Settings**. Use the navigating key **DIR/OK** to select, and press down to confirm and enter the sub-menu. Press **ESC** to go back to the previous menu.

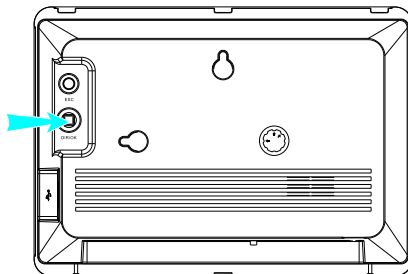
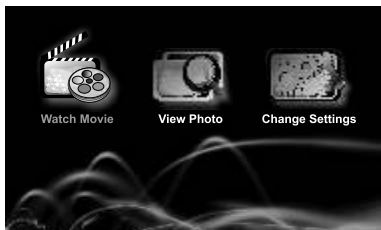

SETUP

WATCH MOVIE

1. Navigate the cursor to **Watch Movie**, press **DIR /OK** to confirm and enter the sub-menu.

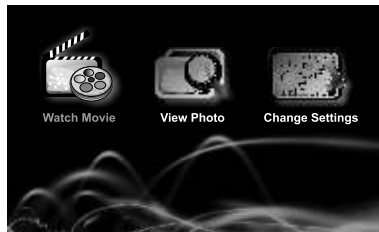

2. Navigate the cursor to **USB Disk** or **Memory Card** to select the storage base, and press **DIR /OK** to confirm.



3. Press **Left (←)** from **DIR /OK** to select **VIDEO**, and select AVI file contained in VIDEO list, press **DIR /OK** to confirm and play the movie file without sound track. Press **ESC** to exit the current operation.
4. When playing a movie, press **Left (←)** to go to the previous movie, and press **Right (→)** to go to the next movie, press down **DIR /OK** to play or pause, and press **ESC** to go back to the file list.

VIEW PHOTO

1. Navigate the cursor to **View Photo**, press **DIR/OK** to enter the sub-menu.



2. Navigate the cursor to **USB Disk**, **Memory Card** or **Internal Memory** to select the storage base, and press **DIR/OK** to confirm.



3. Use the navigating key **DIR/OK** to choose photos for displaying, press **DIR/OK** again for full screen display.

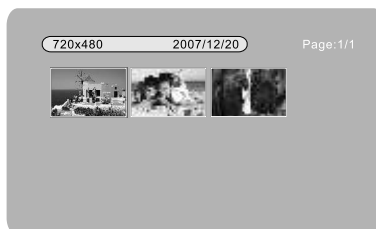

4. Navigate ← to go to the previous picture, and Navigate → to go the next picture.

Note:

1. Built-in memory capacity: up to 15 photos.
2. The speed of displaying pictures will vary. More time is required for larger file sizes. BMP is also slower to load than JPEG formats.

DISPLAYING EFFECT

1. Press **DIR/OK** during full display, select from **Begin Slideshow**, **Zoom in**, **Rotate Left 90°**, **Rotate Right 90°**, **Copy to**, **Settings**.



2. Navigate down to **Begin Slideshow** to start the slideshow.
3. Navigate down to **Zoom in**, press **DIR/OK** to zoom 150%,200%,100%.
4. Navigate down to **Rotate Left 90°**, to counter-clockwise rotate the picture for 90° .
5. Navigate down to **Rotate Right 90°** to clockwise rotate the picture for 90° .
6. Navigate down to **Copy to**, press **DIR/OK** to enter the below screen. Select **Yes** to store the photo to the internal memory, select **No** to cancel the operation.



7. Navigate down to **Settings**, press **DIR/OK** to enter **Setup Menu**.



- a. Select **Photo Setting**, navigate → to enter the **Interval Time**, **Transition Effect**, **Display Mode**, **Browse** menu.
- b. Navigate down to select **Preview**, navigate → to select **Photo Preview / Movie Preview On** or **Off** status.
- c. Navigate down to select **Display Setup**, and navigate → to select **Brightness**, **Contrast**, **Color**.
- d. Navigate down to select **Custom Setup**, and navigate → to select the **OSD Language**, **Repeat Mode**, **Default**.

Note:

Please refer to **Change Settings** for more operation details for this part.

CHANGE SETTINGS

Navigate → to select **Change Settings**, press **DIR/OK** to enter the setting mode.



Settings-Photo Setting

1. Select **Photo Setting**, navigate → to select **Interval Time**, and navigate → again to select the interval time of **5 Sec.**, **10 Sec.**, **15 Sec.**, **30 Sec.**, **1 Min.**, **3 Min** and **Off**. If **Off** has been selected, the operation of **Begin Slideshow** will be invalid.

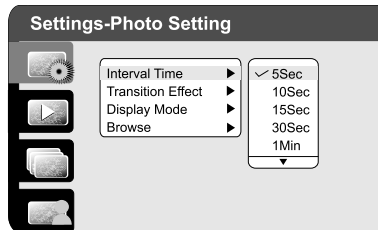

2. Navigate down to **Transition Effect**, there are many effects of displaying to choose. Use the **DIR/OK** key to select your desired effect.

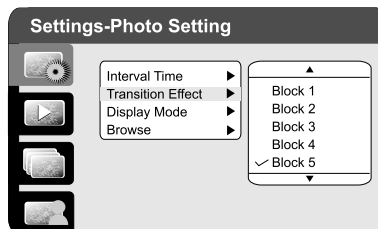

3. Navigate down to **Display Mode**, navigate → to select **Fit Screen**, **Full Screen** or **Enlarged**.

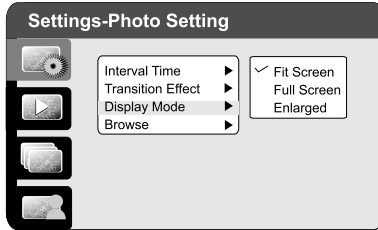

4. Navigate down to **Browse**, navigate → to select **Thumbnail** or **File Manager**.

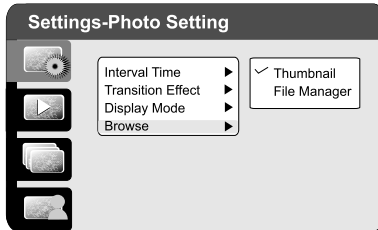

Settings-Preview

1. Navigate down to select **Preview**, and navigate → to select **Photo Preview**.

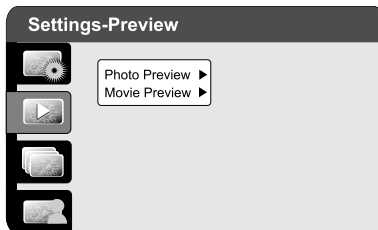

- a. Navigate → to select **Off**, then photos in **USB Disk**, **Memory Card** or **Internal Memory** will be displayed in Fit Screen Full Screen or Enlarged after selecting the storage base.
- b. Navigate down to select **On**, then photos in **USB Disk**, **Memory Card** or **Internal Memory** will be displayed in Thumbnail or File Manager.

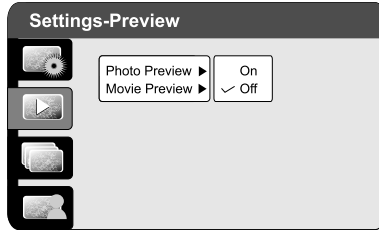

2. Navigate down to select **Movie Preview**.

- a. Navigate → to select **Off**, then movies in the **USB Disk** or **Memory Card** will be played automatically after selecting the storage base.
- b. Navigate down to select **On**, after selecting movies from **USB Disk** or **Memory Card**, systems enter the file list menu.

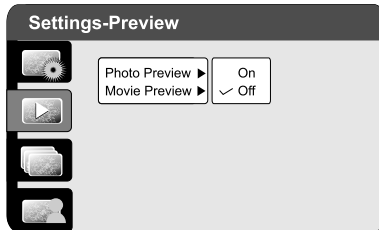

Settings -Display Setup

1. Navigate down to select **Display Setup**, navigate → to select **Brightness**, and navigate → again to select the brightness level.

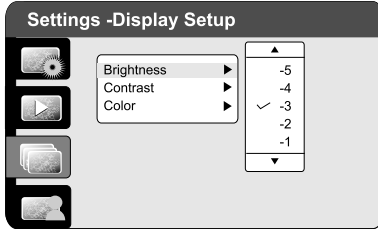

2. Navigate down to **Contrast**, follow the same steps to select the contrast level.

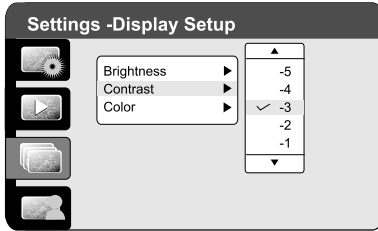

3. Navigate down to **Color** and follow the same steps to select the color level.

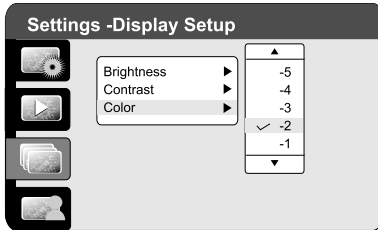

Settings- Custom Setup

1. Navigate down to select **Custom Setup**, navigate → to select **OSD Language**, and navigate → again. Select from the six languages, **English, French, German, Italian, Spanish** and **Dutch**.

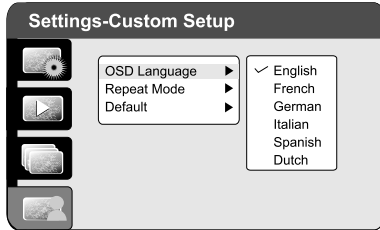

2. Navigate down to **Repeat Mode**, navigate → to select.
 - Select **Off** to cancel the repeat.
 - Select **One** to repeat a chosen photo or movie.
 - Select **Folder** to repeat all photos /movies contained in the folder.
 - Select **All** to repeat photos /movies in **USB Disk, Memory Card** or **Internal Memory**.

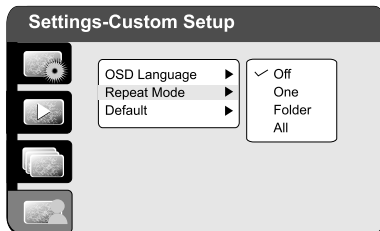

3. Navigate down to **Default**, and navigate → again. Highlight **Confirm** and press **DIR /OK** to confirm, system will be set to the default setting.

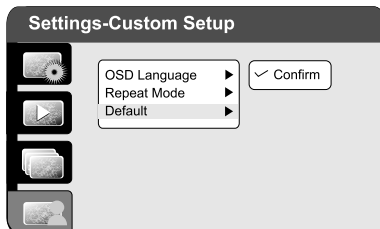

OTHER

DIMENSION AND PARAMETER

Product Name:	Gallery 13-S
Power Supply:	Input 100-240V AC Output 5V DC, 2A
Resolution	480(W)X234(H)X3 Pixels
Screen Size	7"
Screen Ratio	16:9
Dimension:	176 X 126 X 18 mm
Net Weight:	330g

TROUBLE SHOOTING

PHENOMENON	SOLUTION
Cannot turn on the Gallery 13-S	1. Use the adapter to supply power.
Blurred Image	1. Check the original size and quality of the pictures.
Video doesn't play	1. Check video format is MPEG1, MPEG2 or MPEG4 (other format not compatible, no sound when playing video)
Blurred or no picture	1. Smashed screen. 2. Non warrantable damage.
Pixel failure	1. The LCD screen contains 336,960 pixels. Pixels can fail during normal product life. 1 pixel=0.00007% failure rate. One pixel failure /per year of operation is considered normal and not a cause for concern.

SMASHED SCREEN IDENTIFICATION

A Liquid Crystal Display (LCD) screen is a multilayer complex component.

Under the tough outer plastic layer, the glass sandwich beneath holds the LCD crystals in place, which are themselves suspended in fluid. In the unfortunate event of an accident, particularly a sharp localized impact, the glass will break. The tough plastic outer sheet on the surface of the glass keeps all the glass intact underneath, preventing shards from falling out. This is a specific safety feature, particularly implemented for the younger user and also for in-car use. The broken glass normally shows signs of the impact mark and also cracks radiating away. The resultant fluid leakage renders the panel inoperable.

Symptoms are often a dark round mark, a white screen without picture and maybe some multicolored lines. Depending on the individual break, an element of the TV picture may remain for a while, but not for long, as the fluid leaks away. Some inky black staining may also appear upon the crack lines, as the fluid escapes.

Unfortunately a break of this nature is not covered under the manufactures warranty, as it is accidental damage to the product, rather than an original defect from manufacture. Please see below for some sample images of broken LCD panels for reference.



DAMAGE REQUIRING SERVICE

Have the unit serviced by a qualified service technician if:

The unit has been exposed to rain or water.

The unit does not seem to operate normally.

The unit exhibits a marked change in performance.

DO NOT ATTEMPT TO SERVICE THE UNIT BY YOURSELF!



NEXTBASE Gallery 13-S

www.next-base.com
Gallery 13 -S - ENG - MANUAL - NB - A1